

UOVO

Steve Leung



The UOVO collection's design combines artistry and practical function. Its concept and craftsmanship help the furniture fit the luxury contemporary style. It uses fluid and smooth lines to sketch out an advanced metropolitan feel. The curves turn, enclose, bloom and end in ways perfectly controlled to present the finest elegance.

STRUCTURE

Structure in solid wood and plywood, base in metal

SEAT CUSHION

Seat cushion in high density foam polyurethane and dacron

CUSHIONS

Polyester padding and goose down with cotton pre-covering, removable covering in fabric or leather

FINISHING

Upholstered with fabric or leather, feet in silk black lacquered metal

COVERING

Non-removable covering in fabric or leather

SECTIONAL SOFA
31F006

SOFA

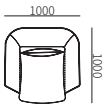

31F006-11
1000*1000*755mm
39.4*39.4*29.7"

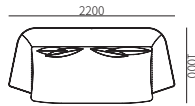

31F006-12
2200*1000*755mm
86.6*39.4*29.7"

LEFT/RIGHT ONE-ARMED SOFA

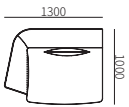

31F006-21
1300*1000*755mm
51.2*39.4*29.7"

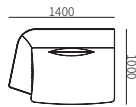

31F006-22
1400*1000*755mm
55.1*39.4*29.7"

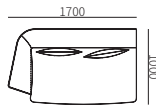

31F006-23
1700*1000*755mm
67.0*39.4*29.7"

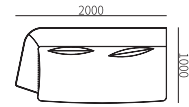

31F006-24
2000*1000*755mm
78.7*39.4*29.7"

SOFA WITHOUT ARM

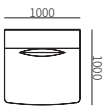

31F006-31
1000*1000*755mm
39.4*39.4*29.7"

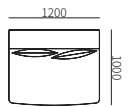

31F006-32
1200*1000*755mm
47.2*39.4*29.7"

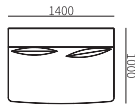

31F006-33
1400*1000*755mm
55.1*39.4*29.7"

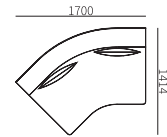

31F006-34
1700*1414*755mm
67.0*55.7*29.7"

LEFT/RIGHT CHAISE

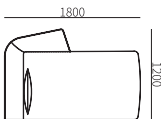

31F006-41
1800*1200*755mm
70.9*47.2*29.7"

LEFT/RIGHT CORNER SEAT

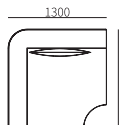

31F006-61
1300*1300*755mm
51.2*51.2*29.7"

COMBINATION SIZE

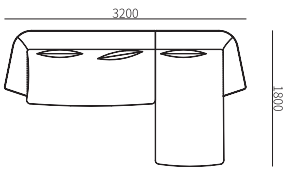

31F006ZH-01
3200*1800*755mm
126.0*70.9*29.7"

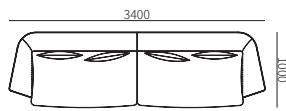

31F006ZH-02
3400*1000*755mm
133.9*39.4*29.7"

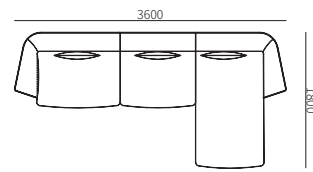

31F006ZH-03
3600*1800*755mm
141.7*70.9*29.7"

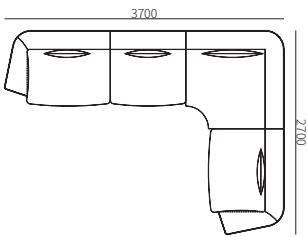

31F006ZH-04
3700*2700*755mm
145.7*106.3*29.7"

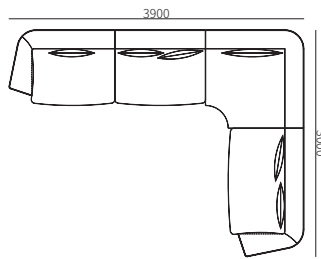

31F006ZH-05
3900*3000*755mm
153.5*118.1*29.7"

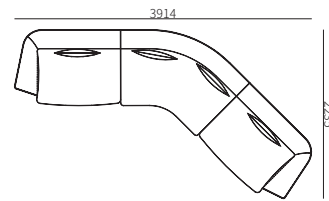

31F006ZH-06
3914*2235*755mm
154.1*88.0*29.7"

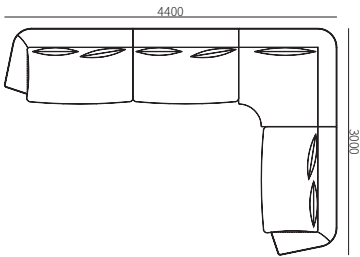

31F006ZH-07
4400*3000*755mm
173.2*118.1*29.7"

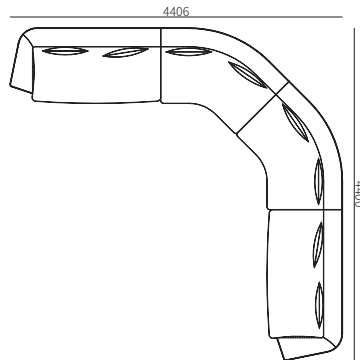

31F006ZH-08
4406*4400*755mm
173.5*173.2*29.7"